

The Fabco-Air all-molded DIN solenoid valve connector/gasket/cord assembly offers a completely molded design that is far better for environmental integrity than field wired versions. The integrated gasket design boasts IP67/NEMA 6 rating and makes it impossible to lose the gasket.

## How to Order

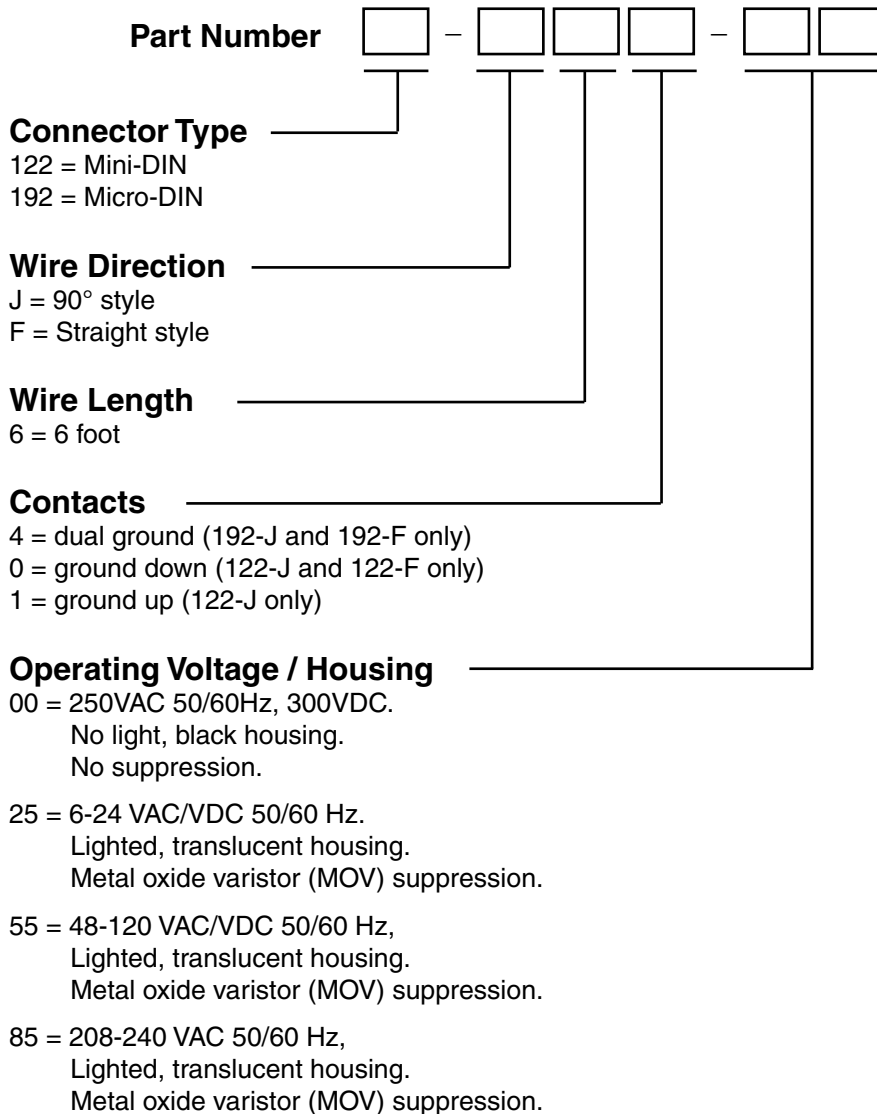

## Ordering Examples

### 192-J64-00

Micro-DIN connector,  
90° wire direction,  
6 foot wire, dual ground,  
250 VAC 50/60Hz, 300VDC,  
no light, black housing,  
no suppression.

### 122-F60-25

Mini-DIN connector,  
straight wire direction,  
6 foot wire, ground down,  
6-24 VAC/VDC 50/60 Hz,  
lighted, translucent housing,  
metal oxide varistor suppression.

## Choose From These Available Models

122-F60-00

122-F60-25

122-F60-55

122-F60-85

122-J60-00

122-J60-25

122-J60-55

122-J60-85

122-J61-00

122-J61-25

122-J61-55

122-J61-85

192-F64-00

192-F64-25

192-F64-55

192-F64-85

192-J64-00

192-J64-25

192-J64-55

192-J64-85

## J Style 90° Connectors

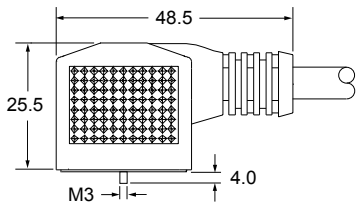

122 Type Connector

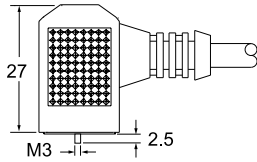

192 Type Connector

Both connector styles have captive stainless steel screw for mounting interface to solenoid valve. Low profile allows use where space is tight. Molded-in gasket is impossible to lose.

122-J61-00  
Shown Left

192-J64-25  
Shown Right



## F Style Straight Connectors

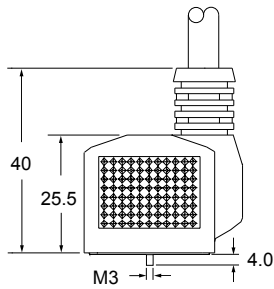

122 Type Connector

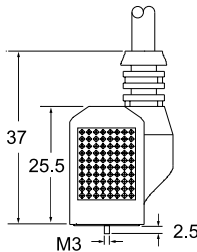

192 Type Connector

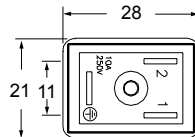

122 Mini-DIN

122-F60-55  
Shown Left

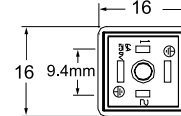

192 Micro-DIN

192-F64-00  
Shown Right



## Wiring Information

Normal polarity:  
 1 = (+) Positive, Hot  
 2 = (-) Negative, Neutral  
 ⊕ = Chassis Ground

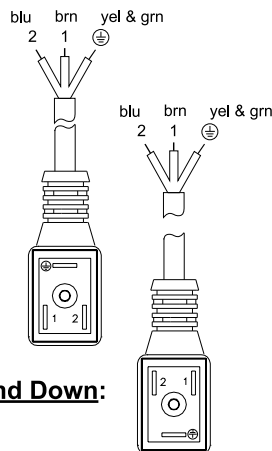

**Ground Up:**

**Ground Down:**

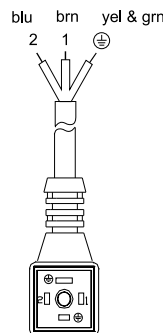

## Technical Data

- Cable type: Pressure extruded PVC jacket.
- Cross section of conductor wire:  
 18 gauge standard for 122 Mini DIN.  
 20 gauge standard for 192 Micro DIN.
- Enclosure material: polyurethane.
- Molded-in gasket material: polyurethane, impossible to lose.
- Ambient temperature:  
 -13°F to 176°F (-25°C to 80°C).
- Slight discoloration may occur to translucent housing after prolonged exposure to UV rays.